

# Shinhoo®



## ERP Circulation Pump

for Heat Pump System

PRODUCT CATALOGUE

---

## ERP Circulation Pumps

---

### 1.ERP Circulation pumps overview

### 2.Type key

### 3.Application

### 4.Operating conditions

### 5.Technical data

### 6.Inlet pressure

### 7.Electric control instructions

### 8.PWM signal control mode

Controlling PWM signal

PWM 1 signal input

PWM 2 signal input

Feedback PWM signal

Master H 7.5&9 Pro

Grand 11 Pro

Grand 13 Pro

Grand 17 Pro

### 9.Construction

Construction advantages of Pro pumps

Material specification

Product range

### 10.Performance curves and technical data

### 11.Dimensions

## ERP Circulation Pumps overview

### Conditions to measure performance

Instructions below are valid for performance curves given in this section below.

- Degassed water was used as pumped liquid when measuring performance.
- Performance of the pumps designed for 1 x 230V was measured with water temperature of +20 °C.
- All the values are approximate and do not guarantee that the pumps actually have the same performance. If it is necessary to calculate a minimum curve, an individual research is required.
- The given performance range is valid for kinematic viscosity of 1mm<sup>2</sup>/s (1 cSt).
- Transformation of hydrostatic head H [m] into pressure p [kPa] was performed for water with density  $\rho = 1,000 \text{ kg/m}^3$ . For pumped liquids with other densities, outlet pressure should be proportional to density.

### How to select a pump: a brief instruction

Prior to selecting a pump, ensure that the following parameters comply with the operating conditions:

- quality and temperature of pumped liquid;
- environmental conditions;
- minimum inlet pressure;
- maximum operating pressure.

See section «Operating conditions»

### Pump size

Pump sizes are selected according to the following parameters:

- required maximum flow in a hydraulic system (Q);
- maximum pressure losses in a hydraulic system (H).

In order to find a duty point, study the description of a certain pump size.

Put the required maximum flow (Q) on the X axis, maximum pressure losses (H) — on the Y axis. See Fig. 1.

**Note:** for more energy effective operation, selecting an excessive pump size is not recommended.

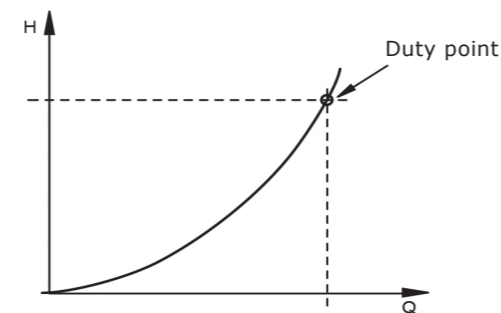

Fig.1 System characteristic

### Application

ERP Circulation Pumps are mainly used in domestic heating and hot water system. The pumps are equipped with control panel on the front for easy operation by users. ERP Circulation Pumps are ideal for:

- Heating pump dual supply system;
- Underfloor heating mixed water system
- Heating pump hot water system;
- PWM signal controlled system;
- HVAC system;
- Boiler system;
- Other heating and cooling occasions, Suitable for refrigerants such as R290.

### Type key

#### Master H 25- 9 130

##### Example

	Master H 25- 9 130
Type range	_____
Nominal diameter of inlet and outlet ports (DN), [mm]	_____
Maximum head [m]	_____
Port-to-port length, [mm]	_____

An automatic pump operating mode can be used in all the circuits of a heating system: one- or two-pipe radiator circuits, under-floor heating circuits, Heat pump system.

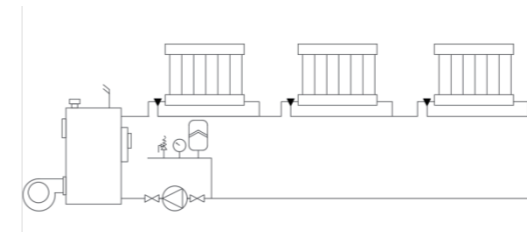

Fig.2 One-pipe heating system

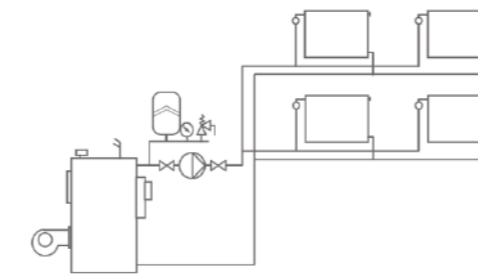

Fig.3 Two-pipe heating system

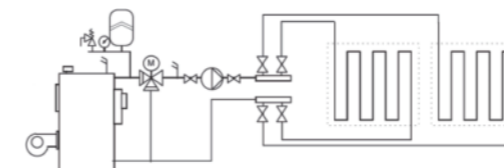

Fig.4 Under-floor heating system

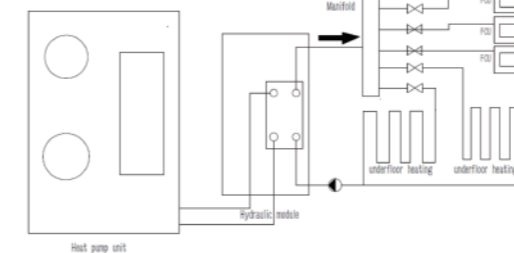
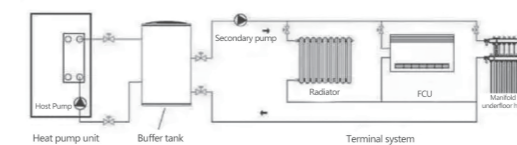

Fig.5 Heat pump system

### Operating conditions

ERP Circulation Pumps can be used with the following liquid types:

- pure, non-viscous, non-aggressive, non-flammable, and non-explosive liquids without solids or fibers;
- cooling liquids without mineral oils;
- softened water.

Kinematic water viscosity  $\nu = 1 \text{ mm}^2/\text{s}$  (1 cSt) at 20 °C.

When a circulator pump is used to pump a more viscous liquid, performance of the hydraulic system decreases. Exclude additives that can negatively effect pump operation.

The pump should be selected according to pumped liquid viscosity.

### Technical data

Supply voltage	1x230V +10% -15%, 50/60 Hz, AC	
Motor protection	Additional external protection is not required	
Degree of Protection	7.5 /9 /17 Pro	IP44
	11/13 Pro	IP67
Insulation class	H	
Relative air humidity	Max. 95 %	
Ambient temperature	From -30 to +55 °C	
Sound pressure	Master H 7.5/9 Pro	≤ 36 dB(A)
	Grand 11 Pro	≤ 34 dB(A)
	Grand 13/17 Pro	≤ 38 dB(A)
Temperature class	TF95	
Design pressure	1.0 Mpa (10 bar)	
Liquid temperature	-20°C ~ +95°C	

### Inlet pressure

To avoid cavitation noise and pump bearings damage, the following minimal pressure should be set up for an inlet port:

Liquid temperature	< 50	95
Inlet pressure	0.3bar	1bar
	3m head	10m head

### Electric control instructions

Necessity in the heating intensity of each room constantly changes and depends significantly on solar activity, time of the day, and individual features of the rooms heated. These are the reasons why a non-adjustable pump can not adapt to changing conditions and works inefficiently. Possible consequences when using non-adjustable pumps:

- excessive pressure in the system;
- noise in thermostatic heads;
- manual control of the heating system;
- excessive electricity consumption.

Adjustable pumps equipped with a frequency converter and integrated software can process an actual system enquiry and automatically adjust to changing conditions.

**Operation principles of non-adjustable and adjustable pumps are compared in the following graphs:**

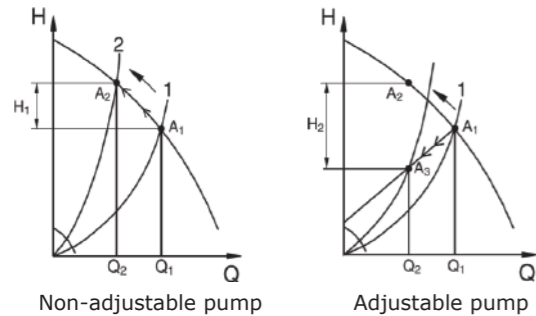

Fig. 6 Changing of the duty point position of an adjustable and non-adjustable pump

If the system adopts a non-adjustable pump, then when thermostatic valve tap is closed, pressure difference on it increases due to the pump head rise in a low performance area. This increased pressure difference on the valve tap leads to local increase in water speed that, therefore, causes an unpleasant cavitation noise. If the system involves ERP Circulation Pump, the head before the valve tap will drop as the supply of the pump decreases. It means that the reason for noise appearance will be eliminated and the supply of heat transfer medium will comply with the real requirement of the system. Also, as the head decreases, ERP Circulation Pump decreases energy consumption.

**PWM signal control mode**

ERP Circulation Pumps can be controlled via an external controller. To do this, use the PWM signal control mode.

**Controlling PWM signal**

After ERP Circulation Pumps connected to a controller, the pump will change the rotational speed depending on the obtained value of the PWM signal operation cycle. A dependency graph is given in Fig. 7 and Fig.8.

**PWM 1 signal input**

Under fixed frequency, different duty cycles correspond to different motor given speed signals. Inverse proportional control mode is adopted. The specific control logic is as follows:

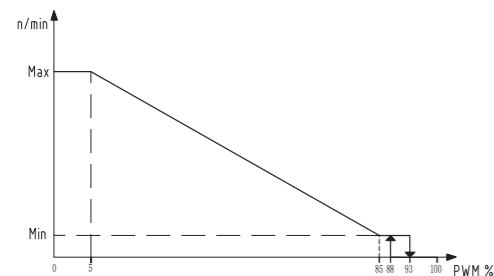

Fig. 7 Controlling PWM 1 signal profile

PWM1 input signal (%)	Water pump status
≤5	The circulating pump operates at the maximum speed
>5~≤85	Pump speed decreases linearly from highest to lowest
>85~≤88	The circulating pump operates at the lowest speed
>88~<93	If the input signal fluctuates near the speed change point, the starting and stopping of the circulating pump will be prevented according to the hysteresis principle
≥93~≤100	Standby, the circulating pump stops running
Recognition accuracy	±1(Example: When the PWM input signal is 20%, the actual duty cycle is in the range of 19% -21%)

**PWM 2 signal input**

Under fixed frequency, different duty cycles correspond to different motor given speed signals. Direct proportional control mode is adopted. The specific control logic is as follows:

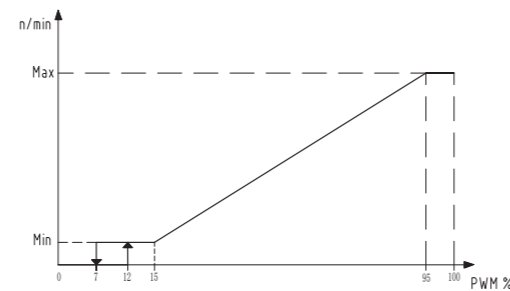

Fig. 8 Controlling PWM 2 signal profile

PWM2 input signal (%)	Water pump status
≤7	Standby, the circulating pump stops running
>7~<12	If the input signal fluctuates near the speed change point, the starting and stopping of the circulating pump will be prevented according to the hysteresis principle
≥12~≤15	The circulating pump operates at the lowest speed
>15~≤95	Pump speed decreases linearly from lowest to highest
>95~≤100	The circulating pump operates at the maximum speed
Recognition accuracy	±1(Example: When the PWM input signal is 20%, the actual duty cycle is in the range of 19% -21%)

A hysteresis area at high values of an input PWM signal protects the pump from unintended cutting off due to the signal fluctuation.

**Feedback PWM signal**

An output PWM signal feedback from the pump can give the information about:

- operation status;
- alarms;
- emergencies.
- Voltage amplitude: 5V~32V
- Frequency range: 75 ± 5% Hz.

The corresponding relationship between the output signal and the operating status of the circulating pump:

**Master H 7.5&9 Pro**

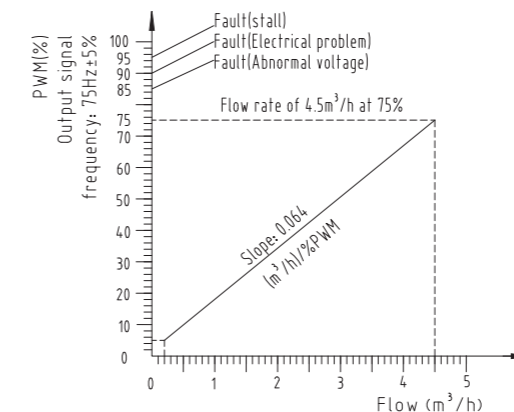

Fig. 9 Feedback PWM signal

PWM output signal(%)	Water pump status	Description
2	Standby	/
5~75	The water pump is operating normally	slope (duty cycle-5) 0.064 (m³/h) /% PWM
85	Abnormal voltage, The pump is not in operation	The pump is in an overvoltage or under voltage protection state.
90	Electrical problem, The pump is not in operation	The pump is in a light load, phase loss, overcurrent, and overheating protection state. Note: After a fault occurs, the PWM feedback needs to be maintained until the fault is solved.
95	The pump is stalled	The water pump is not in operation

**Grand 11 Pro**

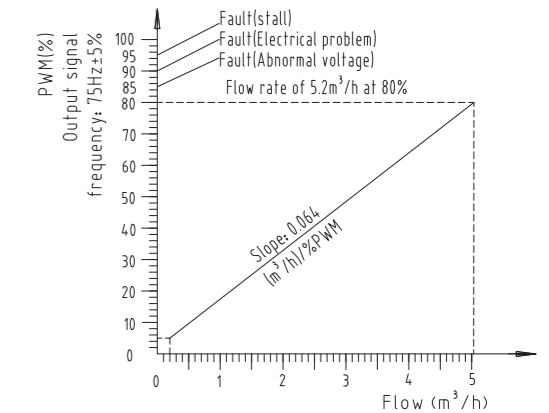

Fig. 10 Feedback PWM signal

PWM output signal(%)	Water pump status	Description
2	Standby	/
5-80	The water pump is operating normally.	Slope,0.064 m³/h /% PWM
85	Abnormal voltage, The pump is not in operation	The pump is in an overvoltage or under voltage protection state.
90	Electrical problem, The pump is not in operation	The pump is in a light load, phase loss, overcurrent, and overheating protection state. Note: After a fault occurs, the PWM feedback needs to be maintained until the fault is solved.
95	The pump is stalled	The water pump is not in operation.

Grand 13 Pro

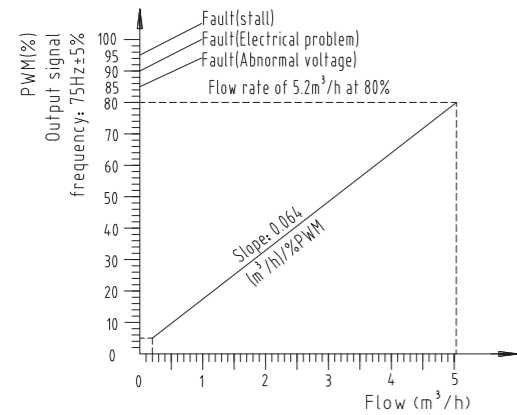

Fig. 11 Feedback PWM signal

PWM output signal(%)	Water pump status	Description
2	Standby	/
5-80	The water pump is operating normally.	Slope,0.064 m³/h /% PWM
85	Abnormal voltage, The pump is not in operation	The pump is in an overvoltage or under voltage protection state.
90	Electrical problem,The pump is not in operation	The pump is in a light load, phase loss, overcurrent, and overheating protection state. Note: After a fault occurs, the PWM feedback needs to be maintained until the fault is solved.
95	The pump is stalled	The water pump is not in operation.

Grand 17 Pro

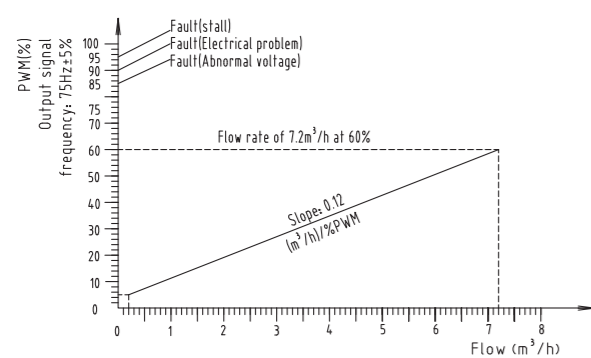

Fig. 12 Feedback PWM signal

PWM output signal(%)	Water pump status	Description
2	Standby	/
5-60	The water pump is operating normally.	Slope, 0.12 m³/h /% PWM
85	Abnormal voltage, The pump is not in operation	The pump is in an overvoltage or under voltage protection state.
90	Electrical problem,The pump is not in operation	The pump is in a light load, phase loss, overcurrent, and overheating protection state. Note: After a fault occurs, the PWM feedback needs to be maintained until the fault is solved.
95	The pump is stalled	The water pump is not in operation.

Construction

ERP Circulation Pumps are of the canned-rotor type. In these pumps, the rotor of the motor is washed by pumped liquid.

Water in such pumps is used to:

- 1.Lubricate the bearings of an motor and remove wear debris.
- 2.Cooling of the stator winding.

Construction advantages:

- An energy-efficient brand new permanent-magnet motor and increased starting torque;
- A ceramic shaft and bearings with the same temperature extension coefficient provide increased reliability of the equipment;
- A thrust bearing is made of carbon that extends the service life of the pump;
- A rotor can and thrust bearing are made of stainless steel to resist corrosion;
- The pump housing is made of cast iron with protective stainless steel anti-rust coating;
- Simplified pump connection to power supply with a plug.

This design adopts a four-pole synchronous permanent-magnet motor and frequency converter. Easy access to the terminal box and cable tension compensator are included. The motor complies with the Low Voltage Directive (EN 60335-2-51). The motor is protected from short circuits.

The motor is protected by electronics of the control unit and does not require any external protection. The pump is connected to power supply via a plug supplied with it.

Material specification

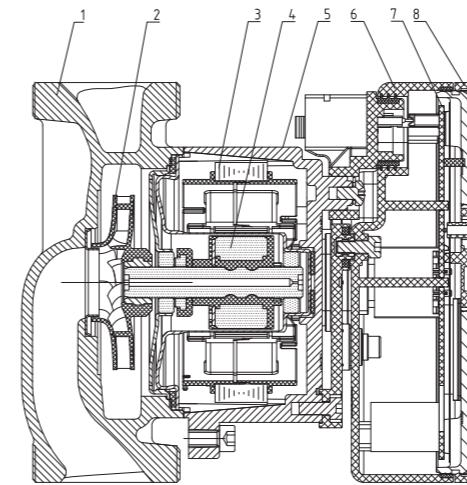

Fig. 13 Sectional drawing

No.	Part	Part material
1	Pump housing	Cast iron
2	Impeller	Composite material
3	Stator assembly	Assembly
4	Rotor assembly	Assembly
5	Stator housing	Aluminum alloy
6	Terminal base	Composite material
7	Driver board	Assembly
8	Terminal cover	Composite material

Product range

Pump model	Protection Degree	Sound pressure dB (A)	Max power (W)	Max flow (m³/h)	Max Head (m)
Master H 20-7.5 Pro	IP44	≤36	60	3.6	7.5
Master H 25-7.5 Pro	IP44	≤36	60	3.8	7.5
Master H 32-7.5 Pro	IP44	≤36	60	3.8	7.5
Master H 20-9 Pro	IP44	≤36	95	4.2	9
Master H 25-9 Pro	IP44	≤36	95	4.5	9
Master H 32-9 Pro	IP44	≤36	95	4.8	9
Grand 25-11 Pro	IP67	≤34	160	5.5	11
Grand 32-11 Pro	IP67	≤34	160	8	11
Grand 25-13 Pro	IP67	≤38	195	5.5	13
Grand 32-13 Pro	IP67	≤38	195	8.5	13
Grand 25-17 Pro	IP44	≤38	350	7	17
Grand 32-17 Pro	IP44	≤38	350	11	17

Performance curves and technical data

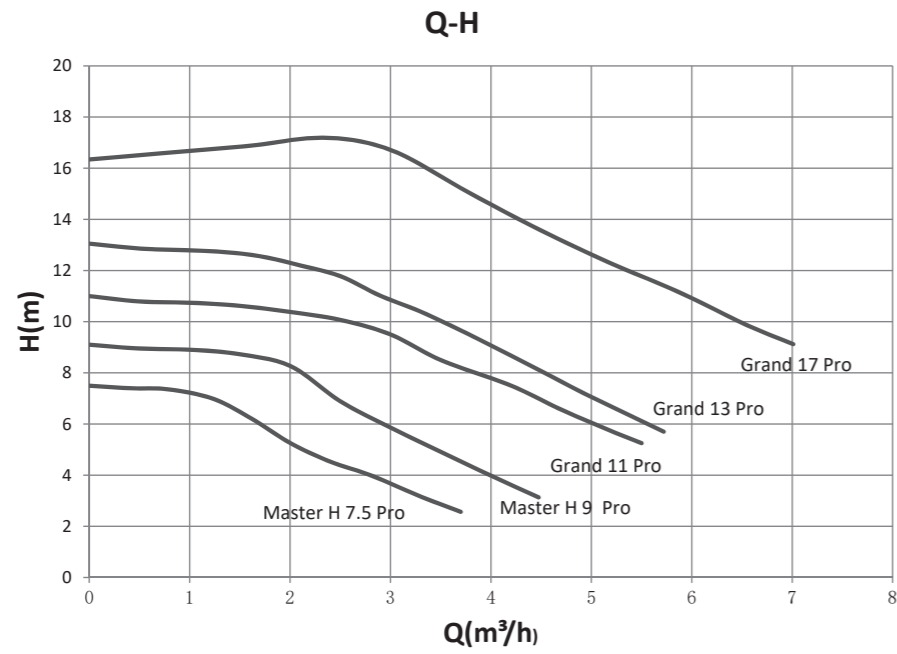

Fig. 14

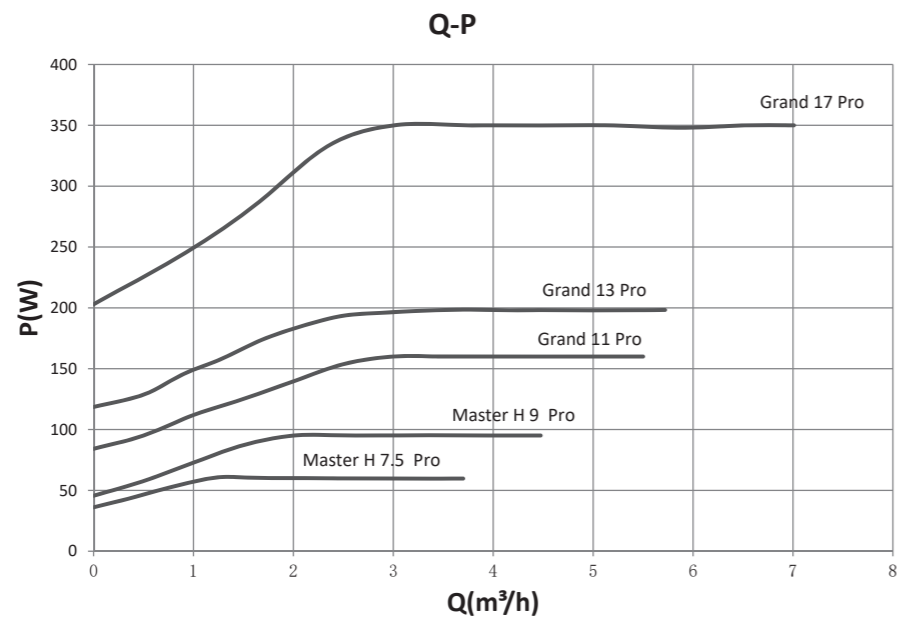

Fig. 15

Dimensions

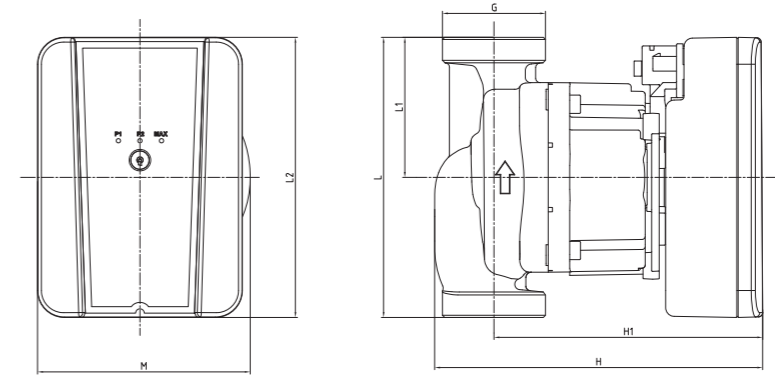

Fig. 16

Pump model	Size (mm)						
	L	M	H	H1	L1	L2	G
Master H 20-7.5 Pro/130	130	99	152	125	65	130	1"
Master H 25-7.5 Pro/130	130	99	152	125	65	130	1 1/2"
Master H 25-7.5 Pro/180	180	99	152	125	90	130	1 1/2"
Master H 32-7.5 Pro/180	180	99	152	125	90	130	2"
Master H 20-9 Pro/130	130	99	152	125	65	130	1"
Master H 25-9 Pro/130	130	99	152	125	65	130	1 1/2"
Master H 25-9 Pro/180	180	99	152	125	90	130	1 1/2"
Master H 32-9 Pro/180	180	99	152	125	90	130	2"
Grand 25-11 Pro/130	130	100	162	125	65	137	1 1/2"
Grand 25-11 Pro/180	180	100	162	125	90	137	1 1/2"
Grand 32-11 Pro/180	180	100	162	125	90	137	2"
Grand 25-13 Pro/130	130	100	162	125	65	137	1 1/2"
Grand 25-13 Pro/180	180	100	162	125	90	137	1 1/2"
Grand 32-13 Pro/180	180	100	162	125	90	137	2"
Grand 25-17 Pro/180	180	123	251.5	197	90	190	1 1/2"
Grand 32-17 Pro/180	180	123	251.5	197	90	190	2"

Anhui Shinhoo Canned Motor Pump Co., Ltd.

Address: No.780, Ming Chuan Road, High-Tech Zone,  
Hefei, Anhui, P.R China

Tel.: +86-551-62379807

E-mail: [info@shinhoodump.com](mailto:info@shinhoodump.com)

For information only. Technical modifications are possible.  
All rights reserved.

**[shinhoodump.com](http://shinhoodump.com)**